

# STC500

STC500 TRUCK CRANE  
50 TONS LIFTING CAPACITY

Quality Changes the World

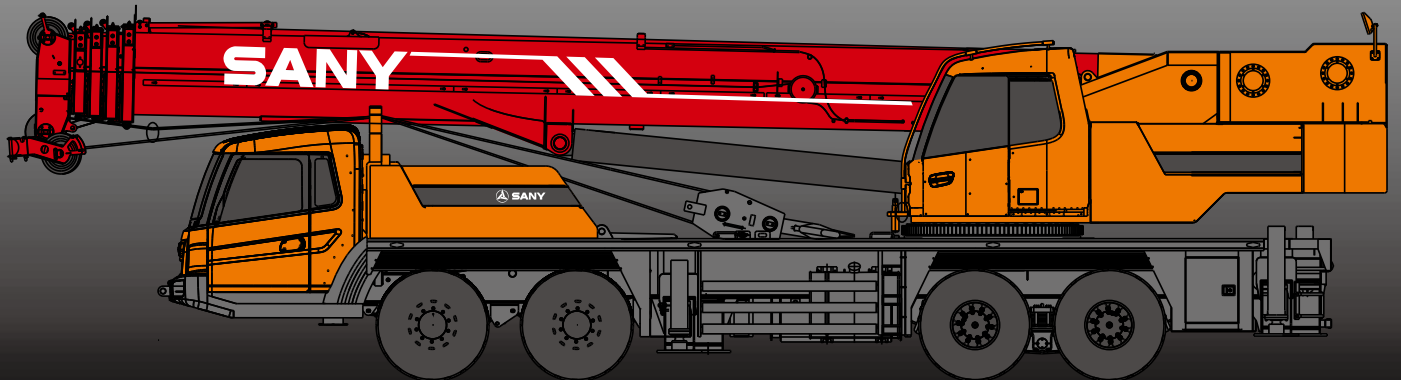

**SANY**

■ SANY Automobile Hoisting Machinery is one of the core business units of Sany Heavy Industry, mainly engaged in the research and development of high-end, mid-to-large tonnage crane series, including mobile crane, crawler crane, tower crane and loader crane. It has two industrial parks in Ningxiang and Huzhou. Since entering the market, the products of Sany Automobile Hoisting Machinery have received worldwide recognition with advanced technology, lean manufacturing, high reliability and excellent service.





# SANY TRUCK CRANE

## CONTENT

04	Icon
05	Selling Points
06	Introduction
09	Dimension
10	Technical Parameter
11	Operation Condition
12	Load Chart
14	Wheel Crane Family Map

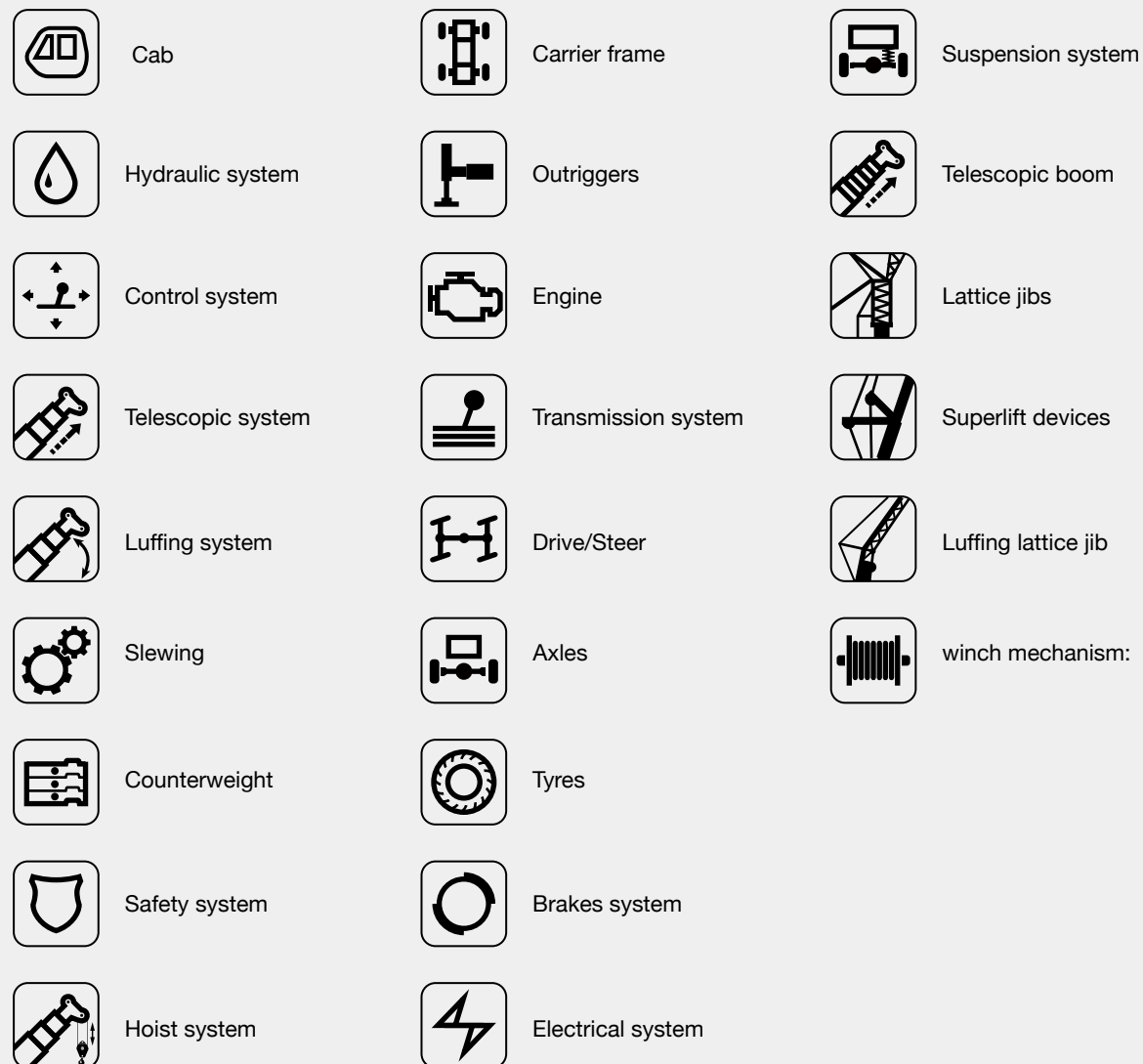

### Excellent and stable chassis performance / chassis system

Double-axle drive is used, providing good trafficability and comfortableness under complex road condition with reliable traveling performance.

Engine has the multimode power output function, which reduces power consumption. The use of tipping over early-warning technology provides high stability and safety of the overall operation.



### Highly efficient, stable, energy-saving and adjustable hydraulic system

Hydraulic system load feedback and constant power control is applied to provide strong lifting capacity and good micro-mobility. Unique steering buffer design is adopted to ensure stable braking operation.

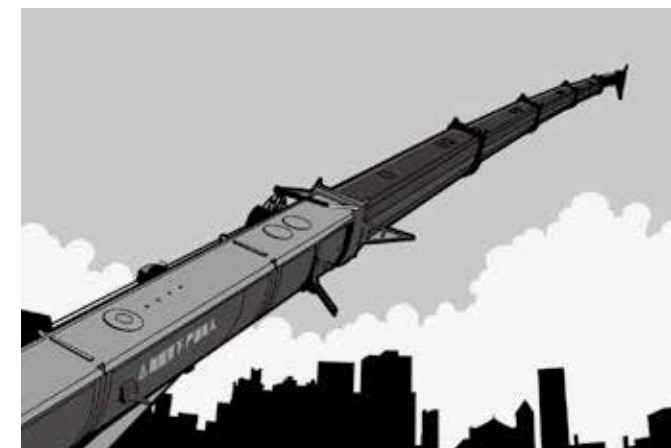

### Ultra long, super strong and highly sensitive load lifting capacity

Five-section boom of high strength steel structure and optimized U-shaped cross section reduces weight significantly with higher safety rates. Jib mounting angles are 0°, 15° and 30°, which ensures fast and convenient change-over between different operating conditions so as to improving working efficiency of the machine.





### Safe, stable, advanced and intelligent electric control system

Self-developed controller SYMC specially for engineering machinery is configured. The adoption of CAN-bus full-digital network control technology ensures stable control signal, simple harness and high reliability. Timely feedback of data information can achieve the monitoring of the overall working status in real-time. The load moment limiter equipped with the comprehensive intelligent protection system is used with accuracy within ±5% to provide a comprehensive logic and interlock control, thus ensuring more safe and reliable operation.

## Superstructure

-  **Cab**
- It is made of safety glass and anti-corrosion steel plate with ergonomic design such as full-coverage soften interior, panoramic sunroof and adjustable seats etc., and humanized design providing more comfortable and relaxing operation experience. The display of load moment limiter integrates main console and operation display system, which clearly show the data of all operating superstructure conditions for lifting operation.

-  **Hydraulic system**
- High-quality key hydraulic components such as main oil pump, rotary pump, main valve, winch motor, and balancing parts etc. are adopted to achieve stable and reliable operation of the hydraulic system. Superior operation performance is guaranteed by accurate parameter matching.
  - Through the adoption of load sensitive variable displacement piston pump, pump displacement can be adjusted in real-time, achieving high-precision flow control with no energy loss during operation.
  - Main valve has flow compensation and load feedback control function, enabling stable and convenient control of single action and combined action under different operation conditions.
  - Winch adopts the electronically controlled variable motor to ensure high operation efficiency. Max. single line speeds of main and auxiliary winches is up to 130m/min.
  - Slewing system is equipped with the integrated slewing buffer valve with free slipping function to ensure more stable starting and control of the slewing operation and excellent micro-mobility.
  - Hydraulic oil tank capacity: 840L.

-  **Control system**
- CAN-bus instrument: CAN-bus instrument with a combined intelligent control electrical system is used for easy reading of the traveling parameters at any time. The engine fault warning function is applied to ensure convenient and fast troubleshooting.
  - With fully security protection system, main and auxiliary winches are equipped with over-rollback limiter and height limiters to prevent over-rolling out and over-hoisting of steel rope, including tip-over and limit angle protection.
  - Load moment limiter: The adoption of high intelligent load moment limiter system can comprehensively protect lifting operation, ensuring accurate, stable and comfort operation.
  - The fault diagnosis system can detect superstructure electricity, chassis (for major safety failure) and engine for fault to ensure reliable operation of the crane.

-  **Luffing system**
- Dead-weight luffing provides more stable luffing operation at low energy loss.
  - Luffing angle:  $-2^{\circ} \sim 80^{\circ}$ .

-  **Telescopic system**
- Five-section boom is applied with basic boom length of 11.5m, full-extended boom length of 43m, jib length of 16m and fully extended boom lifting height of 43.2m respectively. Max. lifting height is 59.2m including jib. It is made of fine grain high-strength steel with U-shaped cross section and with telescopic operation controlled independently by dual-cylinder rope.

-  **Slewing system**
- 360° rotation can be achieved with Max. slewing speed of 2.0r/min. Hydraulic controlled proportional speed adjustment is applied to provide stable and reliable operation of the system. Unique rotary buffer design ensures more stable braking.

## Superstructure

-  **Hoisting system**
- The adoption of pump and motor double variable speed control ensures high efficiency and excellent energy saving functionality. With perfect combination of winch balance valve and unique anti-slip technology, heavy load can lift and lower smoothly. Closed winch brake and winch balance valve effectively prevent imbalance of the hook.
  - One main hook: 610kg or 555kg, one auxiliary hook: 90Kg, and the Max. lifting weight are 50t and 5t. Wire rope of main winch: left-handed wire rope 18-35W×7-1960USZ 220m. Wire rope of auxiliary winch: left-handed wire rope 18-35W×7-1960USZ 130m.

-  **Safety system**
- Load moment limiter: Load moment limiter calculation system based on lifting load mechanical model is established using an analytical mechanics method with rated lifting accuracy up to  $\pm 3\%$  through on-line non-load calibration, providing full protection to lifting operation. In case of overload operation, system will automatically issue an alarm to provide safety protection for manipulation.
  - Hydraulic system is configured with the balance valve, overflow valve and two-way hydraulic lock etc. components, thus achieving stable and reliable operation of the hydraulic system.
  - Main and auxiliary winches are equipped with over roll-out limiter to prevent over rolling-out of wire rope.
  - Boom and jib ends are equipped with height limiters respectively to prevent over-hoisting of wire rope.
  - Equipped with length sensor, angle sensor and press sensor to indicate the working condition of whole crane in real-time, giving an alarm and cutting off the dangerous action automatically.

-  **Counterweight**
- Counterweight is 3500kg, no flexible counterweight.

## Chassis

-  **Cab**
- Cab is made of new steel structure self-developed by SANY, featuring excellent shock absorption and tightness, which is configured with swing-out doors at both sides, pneumatically suspended driver's seat and driver's seat, adjustable steering wheel, large rearview mirror, comfortable driver's chair with a headrest, anti-fog fan, air conditioner, stereo radio and complete control instruments and meters, providing more comfortable, safe and humanized operation experience.

-  **Carrier frame**
- Designed and manufactured by SANY, anti-torsion box structure is welded by fine-grain high-strength steel plate to provide strong load bearing capacity.

-  **Axles**
- Axles 3 and 4 are drive axles and axles 1 and 2 are steering axles. The use of welding process for axle housing provides stronger load bearing capacity.

-  **Engine**
- Type: Inline six-cylinder, water cooled, supercharged and inter-cooling diesel engine.
  - Rated power: 250kw/2100r/min
  - Environment-protection: Emission complies with EuroIII standard
  - Capacity of fuel tank: 300L

## Chassis



## Transmission system

- Gearbox: Manual gearbox is adopted with 9-gear and large speed ratio range applied, which meets the requirements of low gradeability speed and high traveling speed.
- Transmission shaft: With optimized arrangement of the transmission shaft, the transmission is stable and reliable. For most optimized transmission, face-tooth coupling transmission shaft is used with large transmission torque .



## Brakes system

- Air servo brakes are used for all wheels with dual-circuit brake system applied, engine is equipped with an exhaust brake.
- Brakes system includes traveling brake, parking brake, emergency brake and auxiliary brake.
- Traveling brake: All wheels use the air servo brakes and dual-circuit brake system.
- Parking brake: Force driven by accumulator is applied on the third to fourth axle.
- For emergency brake, accumulator is used not only for cutting-off brake but also for emergency brake.
- Auxiliary brake is exhaust brake with brake safety ensured while travelling downhill.



## Suspension system

- All axles adopt the plate spring suspension systems with plate spring passed 100,000 fatigue tests and with optimization of performance parameters of the front and rear plate springs applied to ensure strength and also to provide comfort ridding.



## Steering system

- Hydraulic power mechanical steering systems are applied for axles 1 and 2 with unloading valve installed in the steering gear.



## Outriggers

- Four-point supporting of the H-shaped outriggers ensures easy operation and strong stability with max. span up to 6m×7.2m. They are made of fine-grain high-strength steel sheet with full hydraulic transverse telescopic outriggers adopted for first and second outriggers. Vertical cylinder of outrigger adopts bi- directional hydraulic locks to improve safety.



## Tyres

- 12.00R20-20PR×12.



## Electrical system

- With 2\*12V maintenance-free batteries, the crane power can be cut off manually via a mechanical master power switch. The use of CAN-bus control system can achieve information interaction between superstructure and undercarriage.

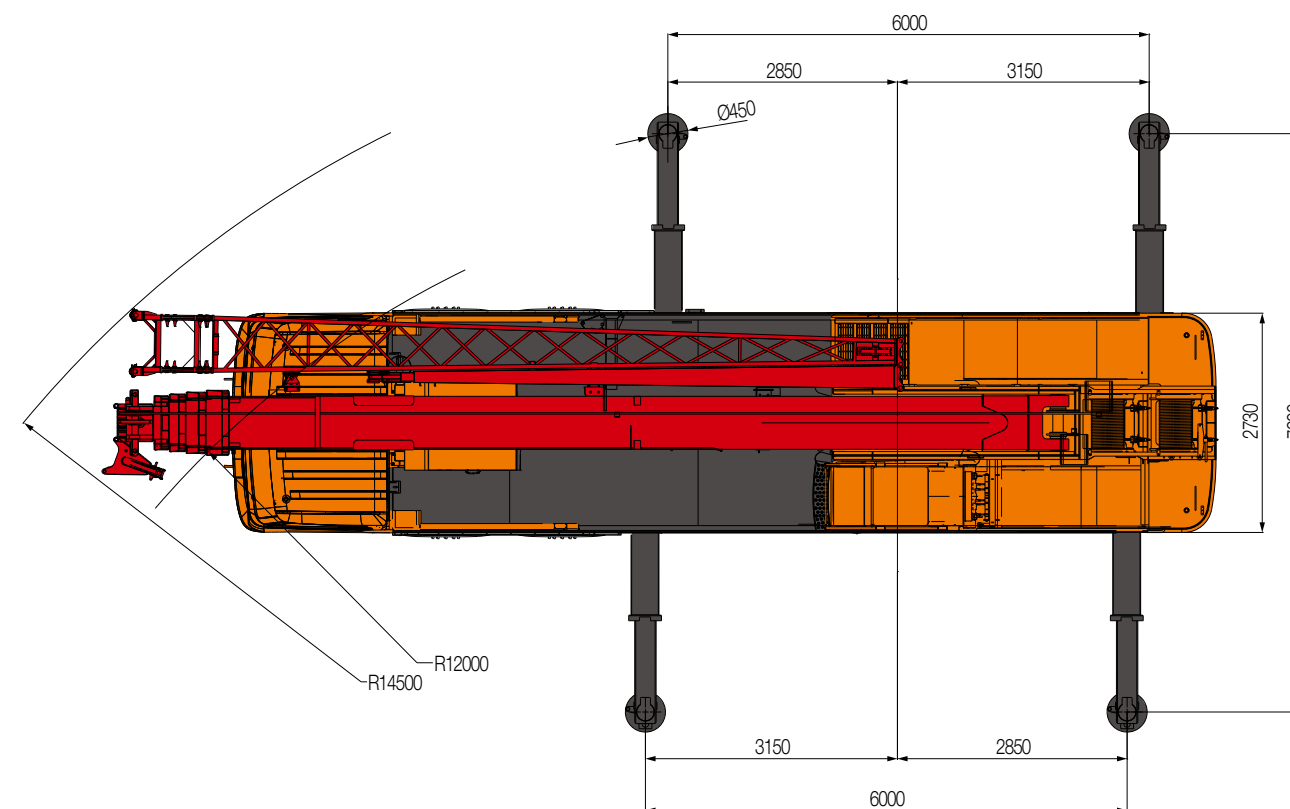
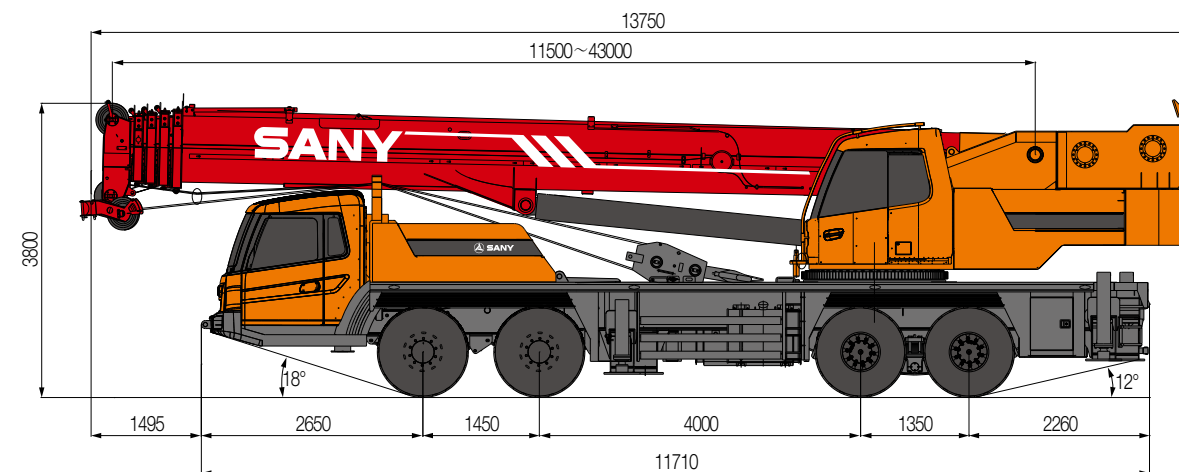

Type	Item	Parameter	
Capacity	Max. lifting capacity	50 t	
Dimensions	Overall length	13750 mm	
	Overall width	2750 mm	
	Overall height	3800 mm	
	Axle distance	Axle-1,2: 1450 mm Axle-2,3: 4000 mm Axle-3,4: 1350 mm	
Weight	Overall weight	42000 kg	
	Axle load	Axle load-1,2: 16000 kg Axle load-3,4: 26000 kg	
	Rated power	250 kW/ 2100 rpm	
	Rated torque	1425 N.m/ 1200 rpm	
Traveling	Max.traveling speed	85 km/h	
	Turning radius	Min.turning radius	12 m
		Min.turning radius of boom head	14.5 m
	Wheel formula	8 × 4	
	Min.ground clearance	295 mm	
	Approach angle	18 °	
	Departure angle	12 °	
	Max.gradeability	40%	
Fuel consumption per 100km	≤ 45 L		
Main Performance Data	Temperature range	- 20 °C ~ +45 °C	
	Min.rated range	3 m	
	Tail slewing radius of swingtable	4 m	
	Boom section	5	
	Boom shape	U-shaped	
	Max.lifting moment	Base boom	1774 kN·m
		Full-extend boom	840.8 kN·m
		Full-extend boom+jib	318 kN·m
	Boom length	Base boom	11.5 m
		Full-extend boom	43 m
Full-extend boom+jib		59 m	
Outrigger span (Longitudinal×Transversal)	6 × 7.2 m		
Jib offset	0 °, 15 °, 30 °		
Working speed	Max.single rope lifting speed of main winch (no load)	130 m/min	
	Max.single rope lifting speed of auxiliary winch (no load)	130 m/min	
	Full extension/retraction time of boom	100 / 120 s	
	Full lifting/descending time of boom	80 / 80 s	
	Slewing speed	0 ~ 2.0 r/min	
Aircondition	Aircondition in up cab	Heating/Cooling	
	Aircondition in low cab	Heating/Cooling	

STC500 Working Ranges

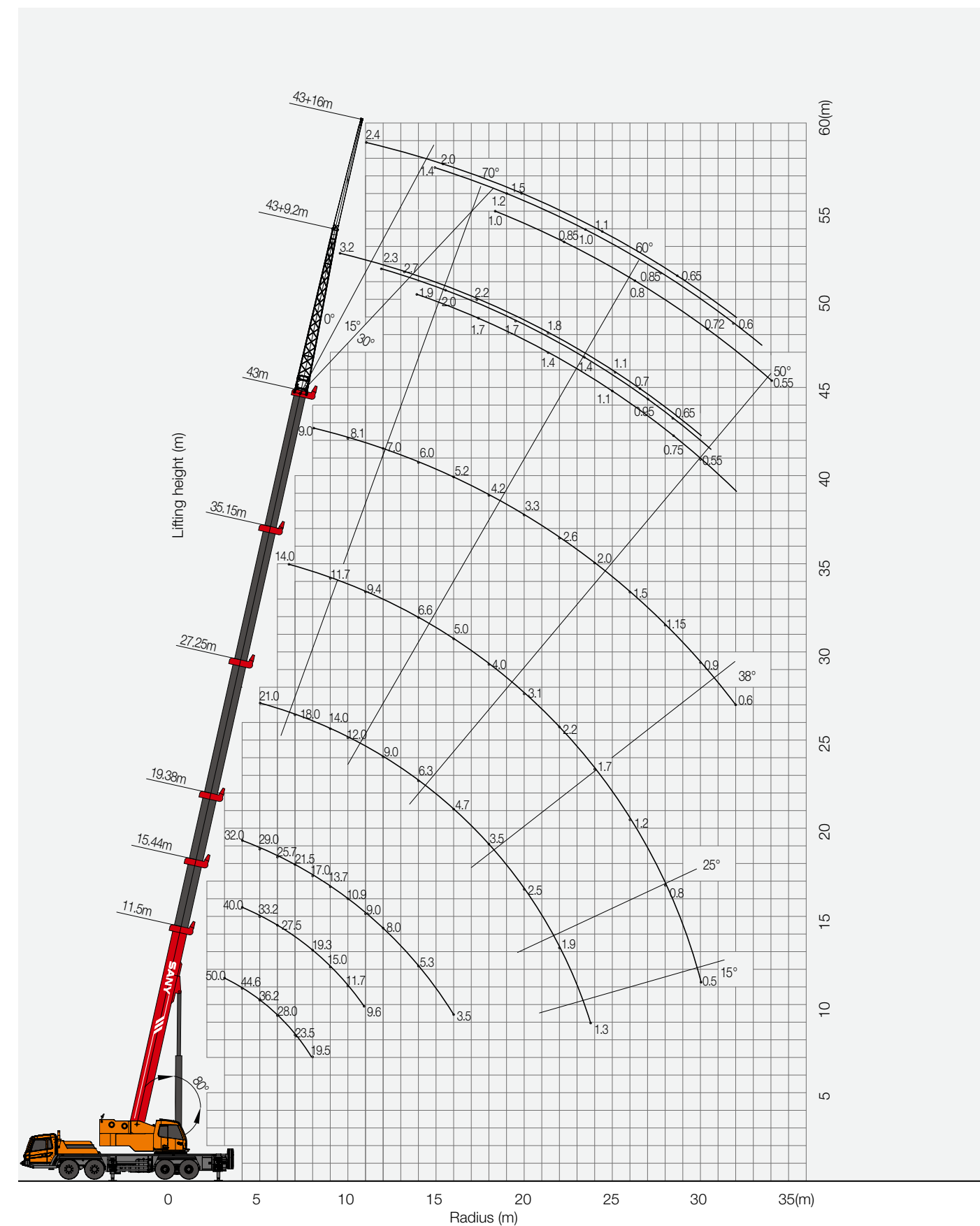



Unit:Kg

**Prerequisites**

- ① Boom operating conditions(fully extended boom length),min. length is 11.5m and max.length is 43m
- ② The span of outriggers is 6m×7.2m
- ③ 360°rotation is applied
- ④ Counterweight is 3.5T

Working range(m)	Main boom											Working range(m)
	11.5	15.44	19.38	19.38	27.25	27.25	35.15	35.15	39	39	43	
3	50000	40000	32000	21500								3
3.5	50000	40000	32000	21500								3.5
4	44600	40000	32000	21500								4
4.5	40000	36000	31000	21500	21000	15000						4.5
5	36200	33200	29000	20000	21000	15000						5
5.5	32000	30000	27500	19000	21000	14500						5.5
6	28000	27500	25700	18100	21000	13700	14000	9000				6
6.5	25800	25500	23900	17500	19500	12800	14000	9000				6.5
7	23500	23200	21500	17000	18000	12100	14000	9000	11500	9000		7
7.5	21400	21200	18600	16200	16800	11500	13500	8500	11500	9000		7.5
8	19500	19300	17000	15600	15800	11000	12700	8500	11000	9000	9000	8
9	15300	15000	13700	13800	14000	10000	11700	7800	10500	8500	8500	9
10		11700	10900	12000	12000	9000	10700	7100	10000	8000	8100	10
11		9600	9000	10600	9900	8200	9400	6400	9000	7500	7800	11
12		8000	8000	8700	9000	7500	8500	5800	8000	7000	7000	12
14			5300	6400	6300	6100	6600	5000	6300	5900	6000	14
16			3500	4600	4700	5000	5000	4400	5000	5000	5200	16
18					3500	4100	4000	3800	4000	4000	4200	18
20					2500	3000	3100	3200	3200	3500	3300	20
22					1900	2300	2200	2700	2400	2800	2600	22
24					1300	1800	1700	2400	1800	2100	2000	24
26							1200	1900	1300	1650	1500	26
28							800	1500	900	1300	1150	28
30							500	1000	600	900	900	30
32								800		600	600	32
34										400		34
Number of lines	12	10	8	8	6	6	4	4	4	4	3	Number of lines
Telescoping condition(%)												
Modes	I,II	I	I	II	I	II	I	II	I	II	I,II	Modes
2nd boom	0	50	100	0	100	0	100	0	100	50	100	2nd boom
3rd boom	0	0	0	33	33	66	66	100	83.3	100	100	3rd boom
4th boom	0	0	0	33	33	66	66	100	83.3	100	100	4th boom
Top boom	0	0	0	33	33	66	66	100	83.3	100	100	Top boom

1. Values listed in the table refer to rated lifting capacity measured at flat and solid ground under the lever state of the crane.
2. Value above heavy line shall be determined by strength of the crane and under this line shall be determined by stability of the crane.
3. Rated load values determined by stability shall comply with ISO 4305.
4. Rated lifting capacity listed in the table included weights of lifting hooks (610kg or 555kg of main hook and 90kg of auxiliary hook)and hangers.
5. Rated lifting capacity with pulley at boom tip shall not exceed 4000kg and then subtracts(230kg)to gain rated lifting capacity if the boom is used to lift after the installation of jib.
6. If actual boom length and range are between two values specified in the table, larger value will determine the lifting capacity.

Unit:Kg

**Prerequisites:**

- ① Boom operating conditions(fully extended boom length +jib length),max.length is 43m+16m
- ② The span of outriggers is 6m×7.2m
- ③ 360°rotation is applied
- ④ Counterweight is 3.5T

Main boom angle	Main boom+Jib		
	0°	15°	30°
78°	2400	1450	1000
77°	2400	1400	1000
75°	2300	1300	950
73°	2000	1200	850
71°	1800	1100	850
68°	1500	1000	800
66°	1300	950	760
63°	1100	850	720
61°	950	750	650
58°	650	600	550
56°	500		
Min.elevation angle	55°		

Unit:Kg



















**Prerequisites:**

- ① Boom operating conditions(fully extended boom length +jib length),max.length is 43m+9.2m
- ② The span of outriggers is 6m×7.2m
- ③ 360°rotation is applied
- ④ Counterweight is 3.5T

Main boom angle	Main boom+Jib		
	0°	15°	30°
78°	3500	2400	2000
77°	3200	2300	1900
75°	3000	2200	1800
73°	2700	2000	1700
71°	2500	1800	1600
68°	2200	1700	1400
66°	2000	1500	1300
63°	1800	1400	1100
61°	1500	1200	950
58°	1100	950	750
56°	700	650	550
Min.elevation angle	55°		

# STC500 TRUCK CRANE WHEEL CRANE FAMILY MAP

## TRUCK CRANE

 STC200 Maximum Load Capacity: 20t Telescopic Boom: 4 Sections, 10.6-33m	 STC250 Maximum Load Capacity: 25t Telescopic Boom: 4 Sections, 10.65-33.5m	 STC250H Maximum Load Capacity: 25t Telescopic Boom: 5 Sections, 10.5-39.5m	 STC300S Maximum Load Capacity: 30t Telescopic Boom: 5 Sections, 10.6-40.5m	 STC300TH Maximum Load Capacity: 30t Telescopic Boom: 4 Sections, 10.6-33.5m
 STC300H Maximum Load Capacity: 30t Telescopic Boom: 5 Sections, 10.5-39.5m	 STC500 Maximum Load Capacity: 50t Telescopic Boom: 5 Sections, 11.5-43m	 STC550 Maximum Load Capacity: 55t Telescopic Boom: 5 Sections, 11.5-43m	 STC600S Maximum Load Capacity: 60t Telescopic Boom: 5 Sections, 11.3-43.5m	 STC750 Maximum Load Capacity: 75t Telescopic Boom: 5 Sections, 11.8-49m
 STC800S Maximum Load Capacity: 80t Telescopic Boom: 5 Sections, 12.2-47m	 STC1000 Maximum Load Capacity: 100t Telescopic Boom: 5 Sections, 13.5-50m	 STC1000C Maximum Load Capacity: 100t Telescopic Boom: 6 Sections, 13.25-60m	 STC1000S Maximum Load Capacity: 100t Telescopic Boom: 5 Sections, 12.25-56m	 STC1200S Maximum Load Capacity: 120t Telescopic Boom: 7 Sections, 12.6-63.5m
 STC1300C Maximum Load Capacity: 130t Telescopic Boom: 5 Sections, 13.3-69m	 STC1600 Maximum Load Capacity: 160t Telescopic Boom: 5 Sections, 13.4-62m	 STC2200 Maximum Load Capacity: 220t Telescopic Boom: 6 Sections, 14.55-68m		

## ALL TERRAIN CRANE

 SAC1800 Maximum Load Capacity: 180t Telescopic Boom: 6 Sections, 15.5-62m	 SAC2200 Maximum Load Capacity: 220t Telescopic Boom: 6 Sections, 15.5-62m	 SAC2600 Maximum Load Capacity: 260t Telescopic Boom: 6 Sections, 15.65-73m	 SAC3000 Maximum Load Capacity: 300t Telescopic Boom: 7 Sections, 15.4-80m
 SAC3500 Maximum Load Capacity: 350t Telescopic Boom: 6 Sections, 15.2-70m	 SAC6000 Maximum Load Capacity: 600t Telescopic Boom: 7 Sections, 17.1-90m		

## ROUGH-TERRAIN CRANE

 SRC250 Maximum Load Capacity: 25t Telescopic Boom: 4 Sections, 9.9-31.5m	 SRC350 Maximum Load Capacity: 35t Telescopic Boom: 4 Sections, 10-31.5m	 SRC660 Maximum Load Capacity: 66t Telescopic Boom: 4 Sections, 11.25-34.5m	 SRC550H Maximum Load Capacity: 55t Telescopic Boom: 5 Sections, 11.5-43m	 SRC750 Maximum Load Capacity: 75t Telescopic Boom: 5 Sections, 11.8-45m
 SRC1200 Maximum Load Capacity: 120t Telescopic Boom: 5 Sections, 13-48m				





Quality Changes the World

## SANY AUTOMOBILE HOISTING MACHINERY

Address: SANY Industrial Park, Jinzhou Development Zone,  
Changsha, Hunan, China.  
Service Hotline: 4006098318  
Email: [crd@sany.com.cn](mailto:crd@sany.com.cn)  
For more information, please visit: [www.sanygroup.com](http://www.sanygroup.com)

For our consistent improvement in technology, specifications may change without notice.  
The machines illustrated may show optional equipment which can be supplied at additional cost.

Version: 2015.08

Distributed By: